



DIAMOND DRILLING EXPENDITURES

PAYMENTS TO D.D. CONTRACTOR: **2.15747**

842' FOOTAGE CHARGES = \$ 8,796
 MOBE/DEMOBE CHARGES = \$ 750
 \$ 9,546 → \$ 9,546

PAYMENTS TO ASSAY LAB:

43 SAMPLES GOLD ASSAYS \$ 437.10 → \$ 437.10

TOTAL PAYMENTS TO OTHERS → \$ 9,983.10 (A)

CLAIM FOR FIELD SUPERVISION OF DRILLING:

10 @ 4hr/day = 5 full days @ \$100/day (current going rate) → \$ 500.00 (B)

CLAIM FOR CORE SAMPLE SELECTION, CORE SPLITTING & ASSAY SAMPLE PREPARATION:

6 @ 8hr/day @ \$100/day (current going rate) → \$ 600.00 (C)

CLAIM FOR ALL DIA. DRILL EXPENSES = \$ 11,083.10
(A)+(B)+(C)

FIELD DAY DATES (MAY 10 → MAY 20)

(May 10, 11, 12, 13, 14, 16, 17, 18, 19, 20)

CORE SELECTION, SPLITTING AND

ASSAY SAMPLE PREPAR^N (JULY 18 → AUG 29/99)

(numerous part days during interval)

DRILL HOLE PLAN MAP

SCALE: 1 cm = 50 meters

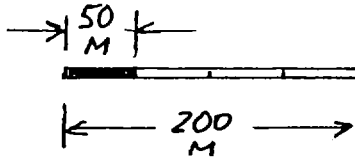

HOLE # MK-932

LENGTH OF HOLE - 256 FT (78 M.)

DIRECTION OF HOLE - AZ. 340° DIP OF HOLE - 45°

CORE DIAMETER - 1 3/8"

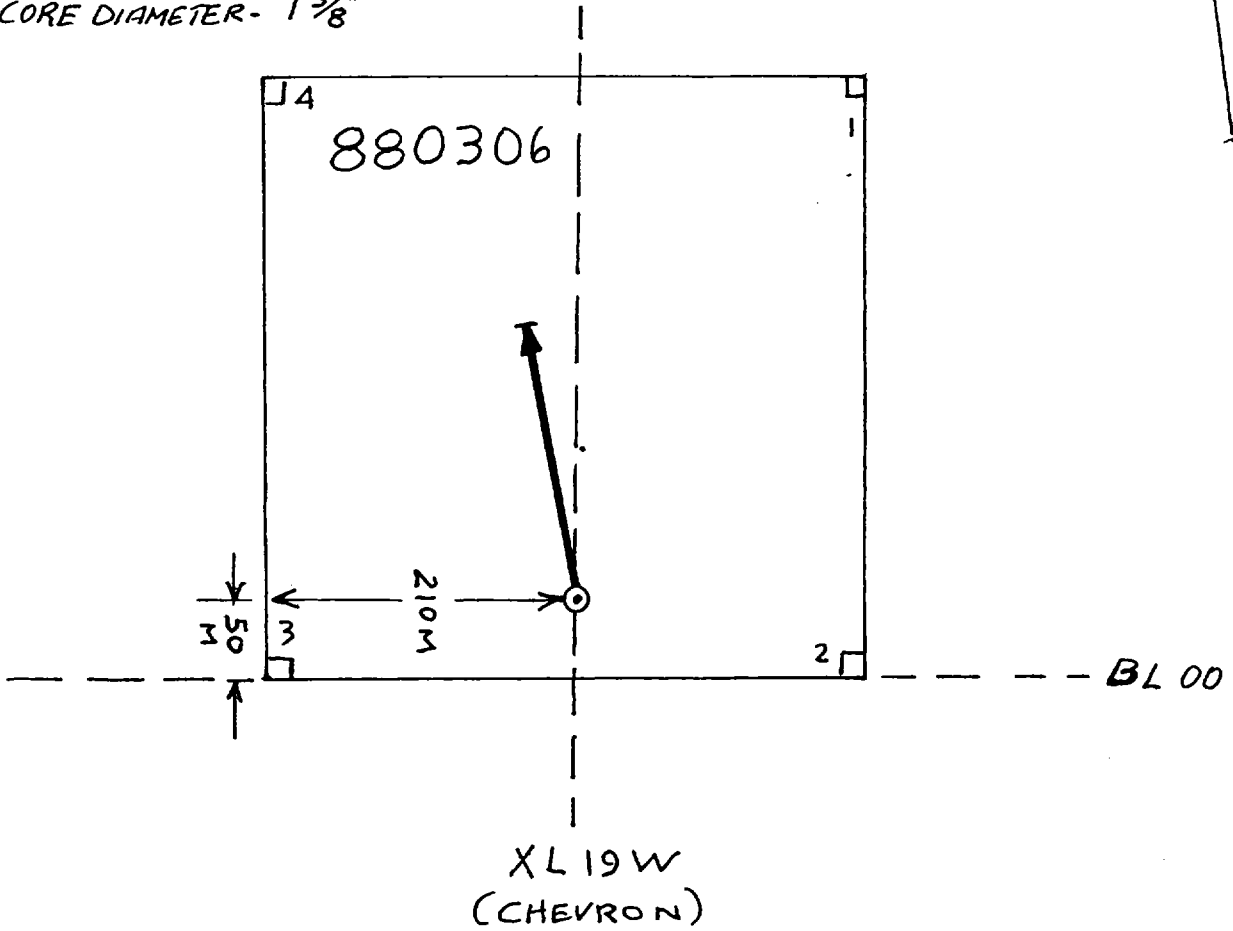
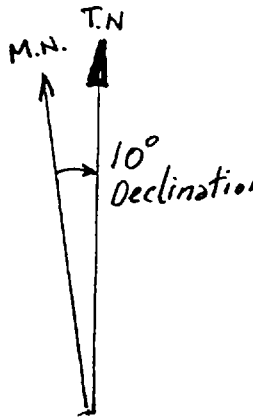

DRILL HOLE CROSS SECTION FACING WEST.

HOLE # MK-932

(CL. NO. 880306)

DIP -45° AZ. 340°

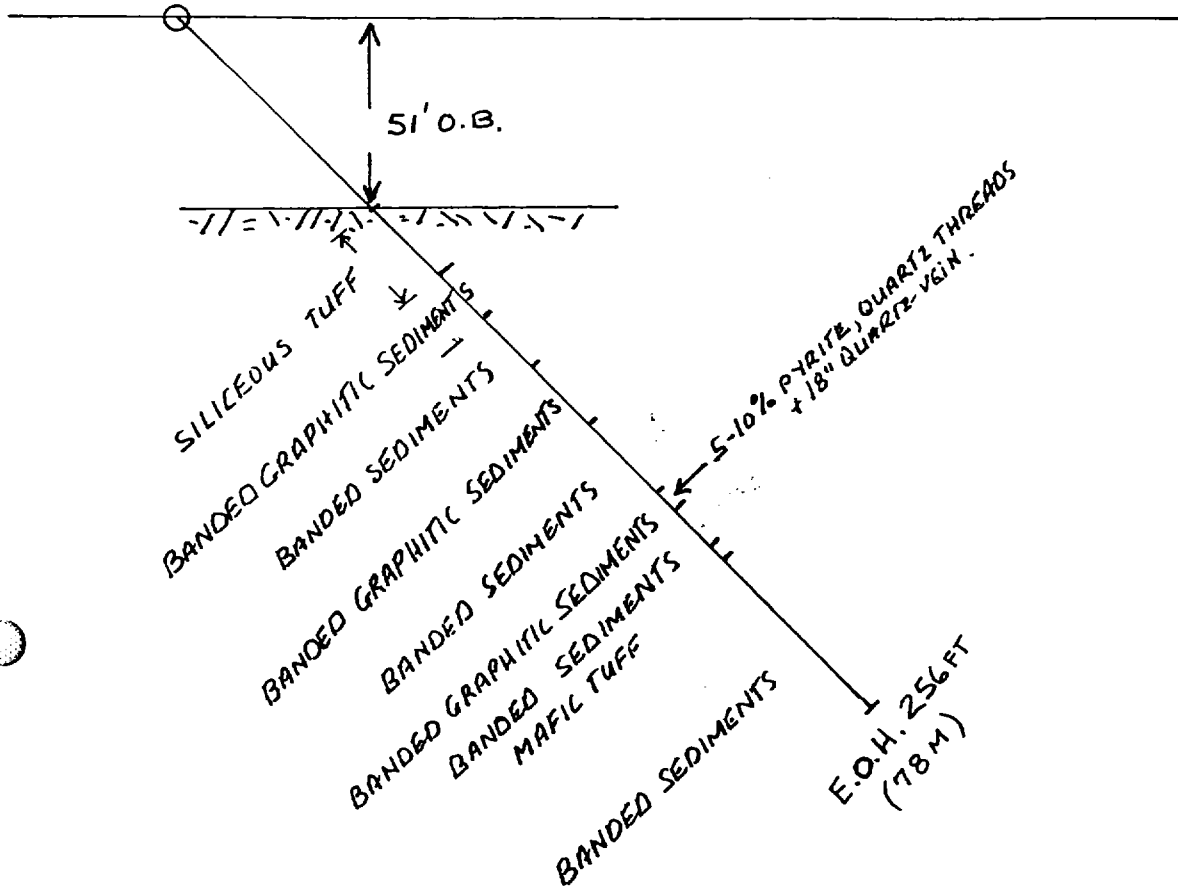
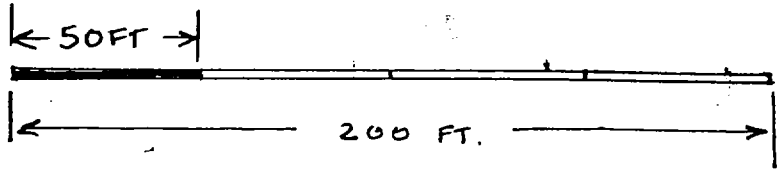

DRILL HOLE PLAN MAP

SCALE: 1 CM = 50 METERS

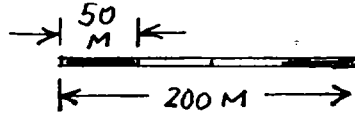

HOLE # MK-934

LENGTH OF HOLE = 336 FT (102.4 M)

DIRECTION OF HOLE = AZ 345°

DIP OF HOLE = -45°

CORE DIAMETER = 1 3/8"

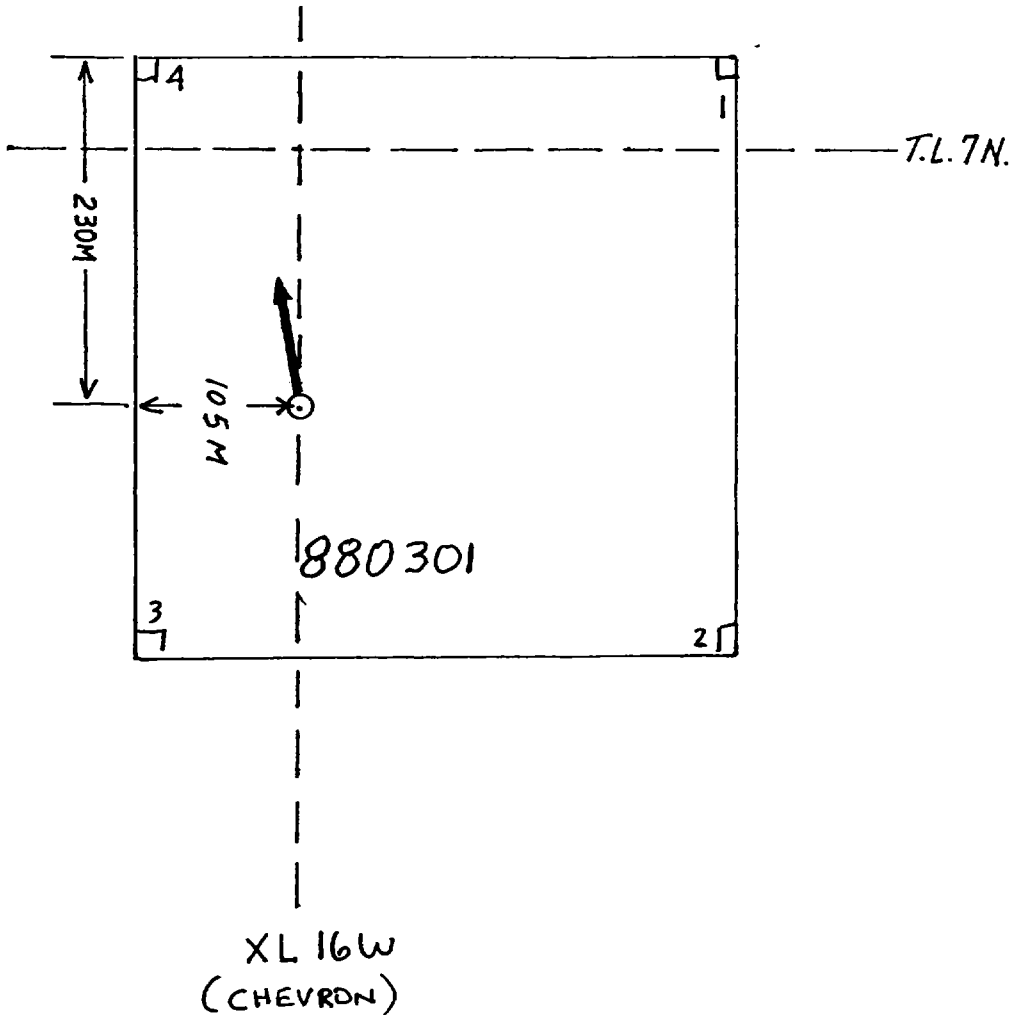
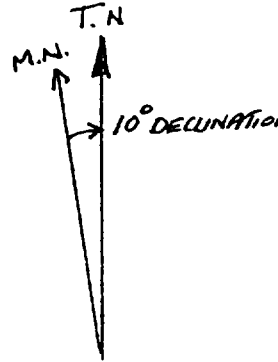

DRILL HOLE CROSS SECTION FACING WEST

HOLE # MK-934

(CL. NO. 880301)

DIP - 45° N 345°

50 FT

200 FT

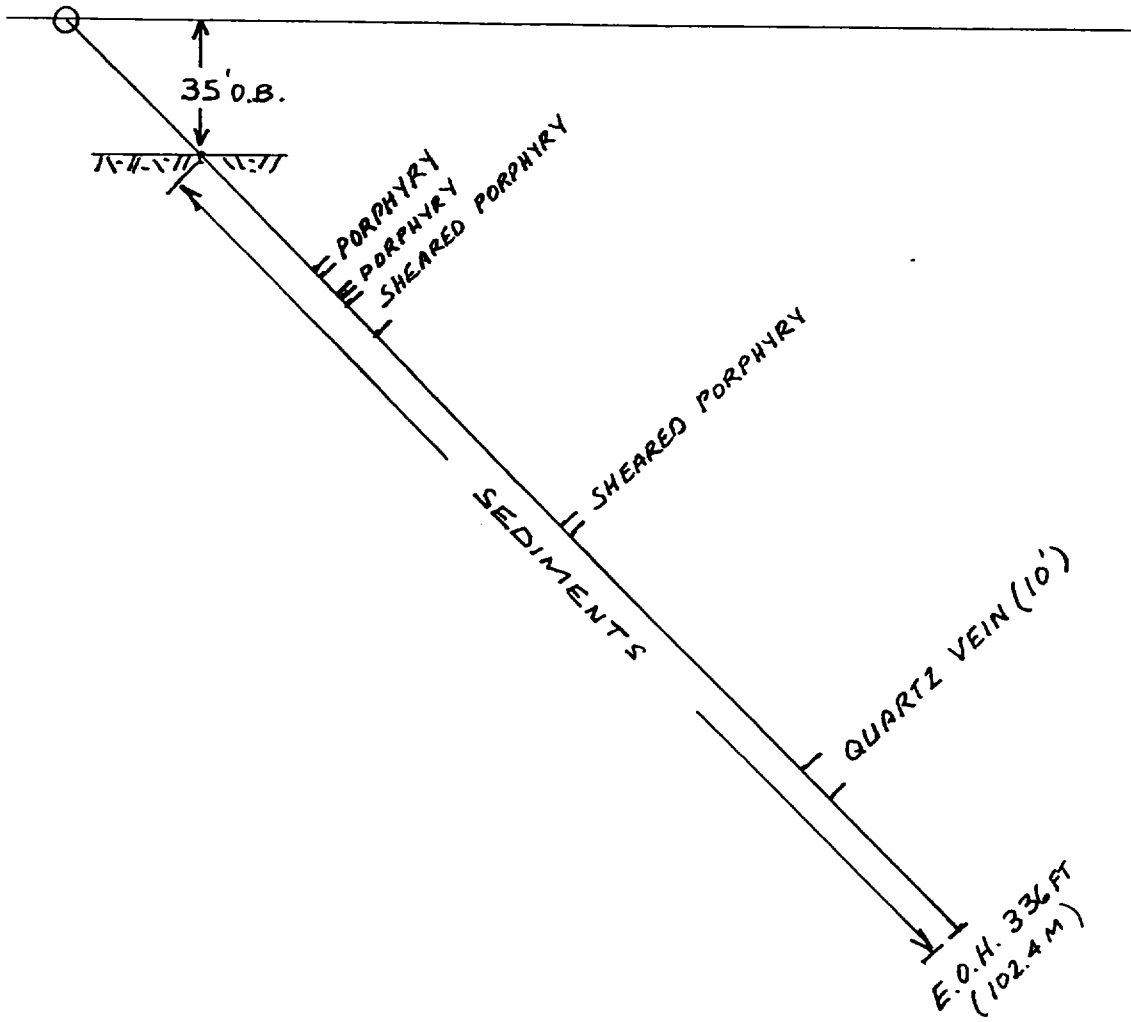

DRILL HOLE PLAN MAP

SCALE: 1CM = 50 METERS

HOLE # MK-935

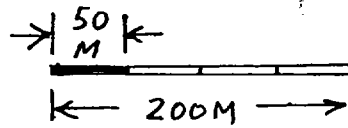

LENGTH OF HOLE - 260 FT. (79.2 M)

DIRECTION OF HOLE - AZ. 0° DIP OF HOLE - 45°

CORE DIAMETER - 1 3/8"

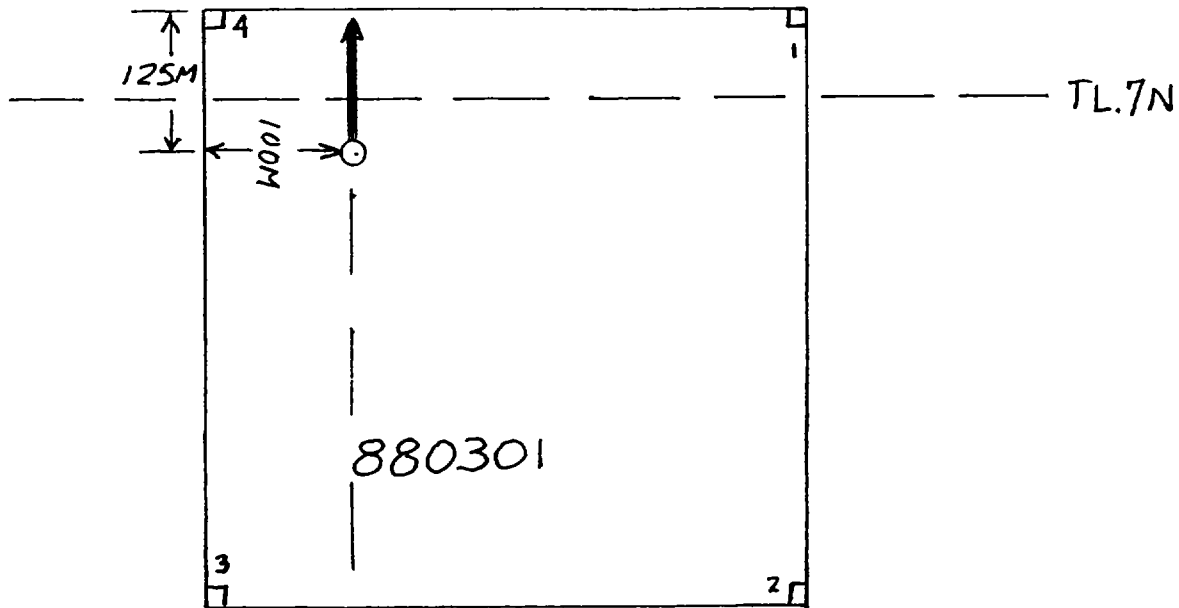
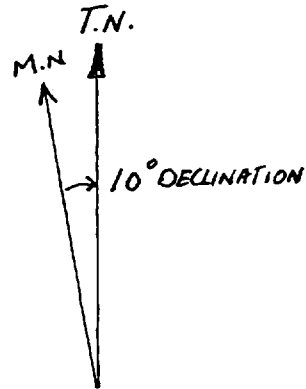

XL16W
(CHEVRON)

DRILL HOLE CROSS SECTION FACING WEST

HOLE # MK-935
(CL. NO 880301)

DIP - 45° AZ. 0°

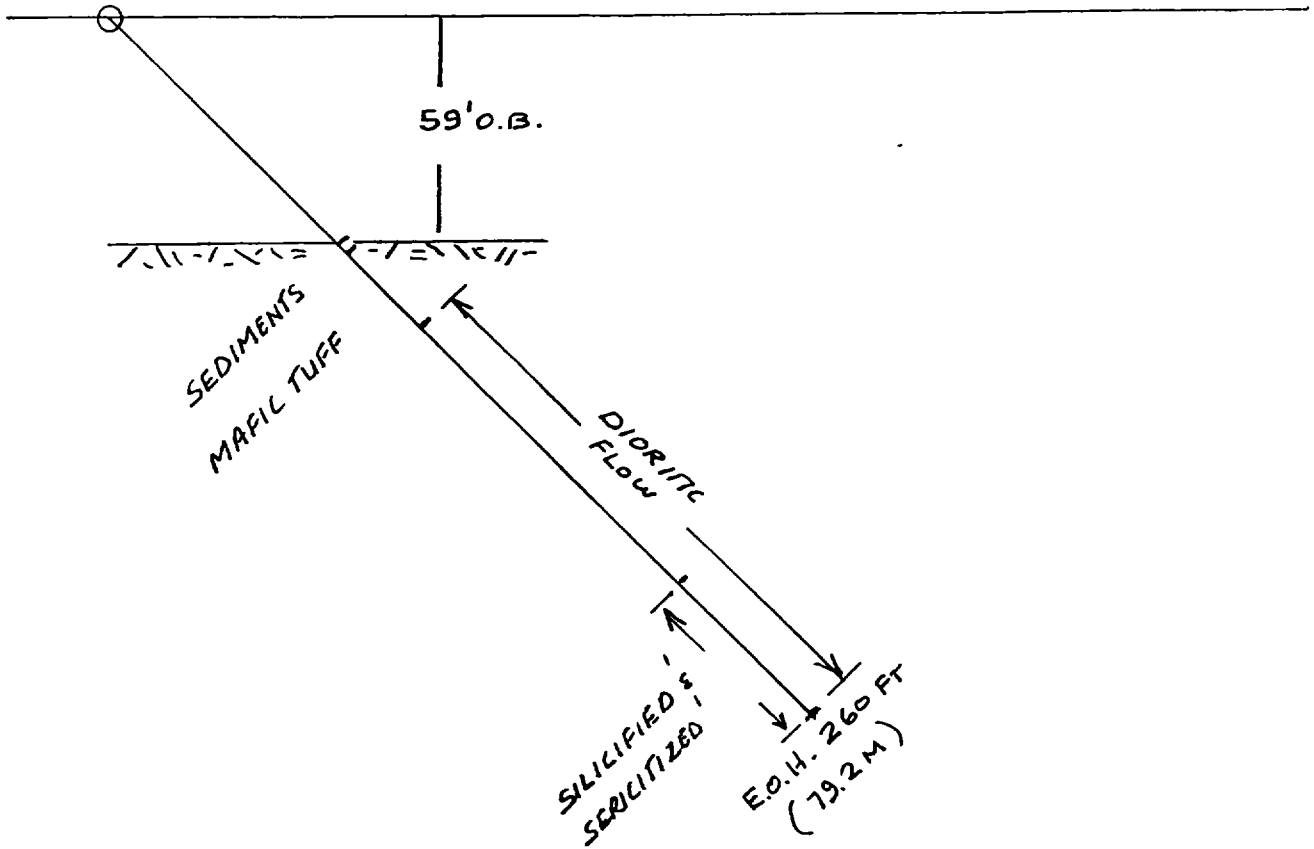
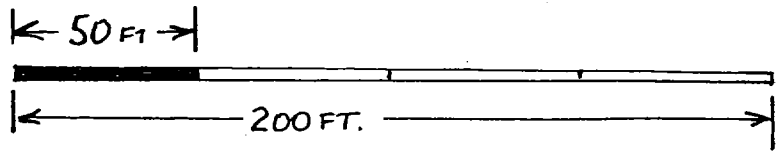



Swastika Laboratories

A Division of TSL/Assayers Inc.

Assaying - Consulting - Representation

Established 1928

Page 1 of 2

Assay Certificate

D.D.H. MK-934

4W-1540-RA1

Company: **J. CROXALL**

Date: JUL-22-94

Project:

Attn: J. Croxall

We hereby certify the following Assay of 33 Core samples submitted JUL-20-94 by .

Sample Number	LOG NO.	Au g/tonne	Au Check g/tonne
6551	170	0.01	Nil
6552	169	Nil	-
6553	168	0.02	-
6554	167	Nil	-
6555	166	Nil	-
6556	165	0.02	Nil
6557	164	Nil	-
6558	163	0.01	-
6559	162	Nil	-
6560	161	0.01	0.01
6561	160	Nil	-
6562	159	Nil	-
6563	158	Nil	-
6564	157	0.01	-
6565	156	Nil	-
6566	155	Nil	-
6567	154	Nil	-
6568	153	Nil	-
6569	152	Nil	-
6570	151	Nil	-
6571	150A	Nil	-
6572	150B	Nil	-
6573	149	0.01	-
6574	148	Nil	-
6575	147	Nil	-
6576	146	Nil	Nil
6577	145	Nil	-
6578	144	0.01	-
6579	143	Nil	-
6580	142	Nil	-

Certified by

P.O. Box 10, Swastika, Ontario P0K 1T0

Telephone (705) 642-3244

FAX (705) 642-3300



Established 1928

Swastika Laboratories

-A Division of TSL/Assayers Inc.

Assaying - Consulting - Representation

Page 2 of 2

4W-1540-RA1

Date: JUL-22-94

Assay Certificate

Company: **J. CROXALL**

Project:

Attn: **J. Croxall**

We hereby certify the following Assay of 33 Core samples submitted JUL-20-94 by .

Sample Number	Log. No	Au g/tonne	Au Check g/tonne
6581	141	Nil	-
6582	140	Nil	-
6583	139	Nil	-

Certified by

P.O. Box 10, Swastika, Ontario P0K 1T0

Telephone (705) 642-3244

FAX (705) 642-3300



Established 1928

Swastika Laboratories

A Division of TSL/Assayers Inc.

Assaying - Consulting - Representation

Assay Certificate

4W-1931-RA1

Company: **J. CROXALL**

Date: AUG-31-94

Project:

Att: J. Croxall

We hereby certify the following Assay of 10 Split Core samples submitted AUG-24-94 by .

Sample Number	LOG. No	Au g/tonne	Au Check g/tonne
MK -935 { 1605	173	Nil	-
1607	175	Nil	-
1804	107	Nil	Nil
1805	108	Nil	-
MK -932 { 1806	109	0.01	-
1807	111	Nil	-
1809	113	Nil	Nil
1811	114	Nil	-
MK -934 { 6588	134	Nil	-
6594	128	Nil	-

Certified by

P.O. Box 10, Swastika, Ontario P0K 1T0

Telephone (705) 642-3244

FAX (705) 642-3300

Swastika Laboratories
P.O. Box 10
Swastika, Ontario
R0K 1T0

INVOICE

NO: 30359
DATE: 07-25-94
PAGE: 1 of 1

SOLD TO:

J. Croxall
152 Brock Avenue,
Timmins,, Ontario
P4N 7P1

SHIP TO:

Same

GST Number: R132862640

ITEM NO.	QUANTITY	UNIT	DESCRIPTION	G	P	UNIT PRICE	AMOUNT
33		Code 1	Au	3		6.500	214.50
33		Code 4	Sample Prep	3		3.000	90.00
			Cert #4W-1540-RA1				
			3-GST @ 7 %				21.95

SWASTIKA LABORATORIES

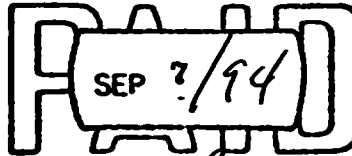

WITH THANKS

PER _____

COMMENTS:

Net 30 Days

TOTAL

385.45

Swastika Laboratories
Box 10
Swastika, Ontario
P0K 1T0

INVOICE

NO: 30730
DATE: 08-31-94
PAGE: 1 of 1

SOLD TO:

J. Croxall
152 Brock Avenue,
Timmins,, Ontario
P4N 7P1

SHIP TO:

Same

GST Number: R132862640

ITEM NO.	QUANTITY	UNIT	DESCRIPTION	G	P	UNIT PRICE	AMOUNT
	10	Code 1	Au	3		6.500	65.00
	10	Code 4	Sample Prep	3		3.000	30.00
			Cert #4W-1931-RA1				
			3-GST @ 7 %				6.65

SWASTIKA LABORATORIES

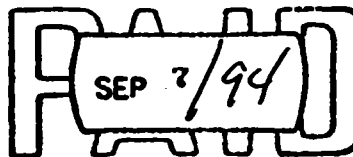

WITH THANKS

PER 

COMMENTS:

Net 30 Days

TOTAL

101.65

SALO ENTERPRISES
BOX 21, 8 CEDAR STREET SOUTH
TIMMINS ONTARIO
P4N 2G4

TO; MR M KANGAS AND MR J CROXALL
TIMMINS

RE; MOBILIZATION OF SALO DRILLING

POINT OF ENTRY; CONNAUGHT

EQUIPMENT FOR PICK-UP; DRILL SKIDDER AND SUPPLIES

POINT OF LANDING; PRICE TOWNSHIP

TIME;

RATE;

AMOUNT DUE; \$750.00

THANK YOU

LARRY SALO

SALO ENTERPRISES
BOX 21, 8 CEDAR STREET SOUTH
TIMMINS, ONTARIO
P4G-2G4

TO; MR. M KANGAS AND MR J CROXALL
TIMMINS, ONTARIO

RE; DEMOBILIZATION OF SALO DRILLING

POINT OF ENTRY; PRICE TOWNSHIP

EQUIPMENT FOR PICK-UP; DRILL, SKIDDER, SUPPLIES

POINT OF LANDING; CONNAUGHT

TIME;

RATE;

AMOUNT DUE: \$750.00

THANK YOU

LARRY SALO

LARRY SALO
General Delivery,
Connaught, Ontario
PCN-1A0 (705)363-2108

MR. MATTI KANGAS
QUEEN STREET
TIMMINS, ONTARIO

RE: DRILLING PRICE TOWNSHIP

HOLE MK-932 TOTAL DEPTH 256 FEET	= \$2,641.92
HOLE MK-935 TOTAL DEPTH 250 FEET	= \$2,686.56
HOLE MK-934 TOTAL DEPTH 336 FEET	= \$3,467.52
TOTAL DUE	= \$8,796.00

HOLE DATA INCLUDED ON DRILL DATA SHEETS

THANK YOU

LARRY J. SALO

D.D. HOLE NO. MK-932 LENGTH 256 Ft.
 DIP -45° VERT. DEPTH OVBDN. 51 Ft.
 Page No. 1 BEARING AZ 340°
 BEGAN MAY 12/94
 FINISHED MAY 13/94

FOOTAGE DRILLED		No	ASSAYS	GRAMS per Mt.
FROM	TO FT.			
0	72.0	104	84.0-87.0	
		105	87.5-90.0	
72.0	96.0	106	96.5-101.0	
		107	103.9-112.0	NIL
		108	146.0-151.5	NIL
		109	176.0-183.3	NIL
		110	220.0-224.0	
		111	224.0-228.5	NIL
		112	228.5-232.0	
96.0	112.0	113	232.0-237.0	NIL
		114	237 - 240.0	NIL
		115	250.5 - 256.0	
112.0	130.0			

CASING
 SILICEOUS TUFF - SHEARED WITH UP TO 1mm. φ GRAINS .STRETCHED MAFIC CLASTS OCCASIONALLY
 (Little or no pyrite) 1 to 1 1/2" LONG BY 1/8" WIDE (SOME ARE FUCHSITIC)
 72.0 - 73.9 BROWN CARBONATE BANDS
 87.5 - 90.0 " " " " " "
 92.5 - 95.5 SLIGHTLY DARKER MATERIAL WITH BANDING BECOMING EVIDENT.
 BANDED GRAPHITIC SEDIMENTS
 97.0 QUARTZ-CARBONATE STRINGER
 98.0-99.0 - SEVERAL 1/2" TO 3/4" W. QUARTZ STRINGERS
 101.0 - 3/4" QUARTZ STR. 106.3 - 1/2" QUARTZ STR. 107.7 - 3/4" QUARTZ STR.
 108.5 - 109.0 SEVERAL 1/4" - 3/8" QUARTZ STRS. WITH OCCASIONAL PYRITE BLEBS.
 BANDED SEDIMENTS - FINE GRAINED ALTERNATING LIGHT GREY & DARK GREY BEDS
 113.0 - 114.0 - 5 QUARTZ STRINGERS 1/4" TO 1/2" WIDE
 117.0 - 119.0 - BROWN CARBONATE BANDS TO 1/8" THICK
 121.0 - 125.0 - " " " " " "
 125.0 - 126.3 - 2 @ 1" to 1 1/2" QUARTZ STRS.

FOOTAGE DRILLED			ASSAYS
FROM	TO FT.		
		127.5-128.0 - 1/4" QUARTZ STRS	
		128.5 - 2" QUARTZ STR.	
130.0	151.5	21.5 BANDED GRAPHITIC SEDIMENTS	
		130.0-139.0 BLACK BANDED	
		139.0-151.5 SILICIFIED, DARK BEDS WITH NUMEROUS NARROW IRREGULAR QUARTZ STRS.	
151.5	176.0	24.5 BANDED SEDIMENTS - LIGHT GREY-BROWN TO DARK GREY BEDS WITH OCCASIONAL MINOR QUARTZ STRS. THROUGHOUT	
176.0	183.0	7.0 BANDED GRAPHITIC SEDIMENTS - CONTAINING FROM 5 TO 10% PYRITE IN SPOTS AND QUARTZ THREADS THROUGHOUT. 176.0-177.5 QUARTZ VEIN	
183.0	197.0	14.0 BANDED SEDIMENTS - EXTREMELY FINE-GRAINED BEDS UP TO 1" WIDE	
197.0	201.0	4.0 MAFIC TUFE - SOFT DARK GRAINS UP TO 1/4", DARK GREEN-BLACK MOTTLED APPEARANCE	
201.0	256.0	55.0 BANDED SEDIMENTS - NUMEROUS QUARTZ STRS. AND THREADS (END OF HOLE)	

D.D. HOLE NO. MK-934
 DIP -45° AZ 345° BEARING

LENGTH 336 FT
 VERT. DEPTH OVBON. 35 FT

BEGAN MAY 18/94
 FINISHED MAY 20/94

Page No. 1

A4

FOOTAGE DRILLED		No	ASSAYS	GRADES FOR FRAME
FROM	TO FT			
0	50			
50.0	53.2	116	52.0-56.0	
53.2	70.5	117	56.0-61.0	
70.5	81.0	118	61.0-66.0	
81.0	92.5	119	66.0-71.0	
92.5	103.5	120	71.0-76.0	
103.5	105.5	121	76.0-81.0	
105.5	116.0	122	81.0-85.5	
116.0	122.5	123	85.5-89.5	
122.5	124.5	124	89.5-92.5	
124.5	125.5	125	92.5-96.5	
125.5	126.5	126	96.5-103.5	
126.5	127.5	127	103.5-106.0	
127.5	128.5	128	106.0-116.0	NIL
128.5	129.5	129	116.0-120.0	
129.5	130.5	130	120.0-125.0	
130.5	131.5	131	125.0-129.0	
131.5	132.5	132	129.0-133.5	
132.5	133.5	133	133.5-135.0	

FOOTAGE DRILLED		No	ASSAYS	grams per ounce
FROM	TO			
116.0	124.8	134	138.0-142.0	NIL
	8.8			
124.8	142.0	135	142.0-146.0	
	17.2			
		136	146.0-148.0	
		137	148.0-154.0	
		138	154.0-160.0	
		139	160.0-164.0	NIL
142.0	181.0	140	164.0-168.0	NIL
	39.0			
		141	168.0-173.0	NIL
		142	173.0-181.0	NIL
		143	181.0-186.0	NIL
		144	186.0-190.0	0.01
		145	190.0-196.0	NIL
		146	196.0-201.0	"
		147	201.0-206.0	"
		148	206.0-212.0	"
181.0	183.0	149	212.0-218.0	0.01
	2.0			
183.0	186.0	150	228.0-232.0	NIL
	3.0			
		151	234.5-239.0	"
		152	247.5-252.3	"

FOOTAGE DRILLED		No	ASSAYS	grams Au per ounce
FROM	TO FT.			
186.0	190.0	153	253.5-256.0	NIL
190.0	218.0	154	256.0-260.0	"
190.0	218.0	155	260.0-266.5	"
		156	266.5-271.5	"
		157	271.5-276.5	0.01
218.0	247.5	158	276.5-281.0	NIL
		159	281.0-286.0	"
		160	286.0-292.0	"
247.5	251.5	161	292.0-297.5	0.01
251.5	253.5	162	297.5-301.0	NIL
251.5	253.5	163	301.0-304.5	0.01
253.5	262.0	164	304.5-309.0	NIL
253.5	262.0	165	309.0-314.0	0.02
253.5	262.0	166	314.0-319.0	NIL
		167	319.0-323.5	"
262.0	272.0	168	323.5-328.5	0.02
272.0	276.0	169	328.5-333.0	NIL
		170	333.0-336.0	0.01
			E.O.H.	

FOOTAGE DRILLED		ASSAYS
FROM	TO FT.	
276.0	286.0	10.0 QUARTZ VEIN WITH OCCASIONAL DARK INCLUSIONS AND NARROW ANKERITIC SECTION DISS. PYRITE ALONG INCLUSION EDGES
286.0	288.5	2.5 SEDIMENTS - GREY WITH MINOR SERICITE
288.5	336.0	47.5 SEDIMENTS - LARGELY GREY/BLACK ALTERNATING BANDS, OCCASIONAL NARROW SERICITIC SECTIONS TO 12" MAX. EACH - 298.8 - 299.3 POSSIBLE 15" WIDE PORPHYRY DIKE - 293.3 - 302.4 CONTAINS NUMEROUS QUARTZ STRS. THROUGHOUT, SERICITIZED - POSSIBLE 16" WIDE VEIN ENANG @ 296.0 - CORE DARKENS 301.5 - 305.0 - HEAVILY SERICITIZED @ 305 TO 309 WELL MINERALIZED WITH PYRITE - DARK GREY/BLACK BANDS, 1 TO 2% PYRITE @ 309.0 & 325.0 - NARROW QUARTZ STRS. SPATTERED WITH 5-8% PYRITE - BLACK/GREY BANDED WITH 1 TO 2% PYRITE 325.0 TO 336.0 (END OF HOLE)

D.D. HOLE NO. MK-935
 DIP 45° BEARING A20°

LENGTH 260.0 FT
 VERT. DEPTH OVDN. 59.0 FT.

BEGAN MAY 14/94
 FINISHED MAY 17/94

Page No. 1

FOOTAGE DRILLED			ASSAYS	GRAMS PPM
FROM	TO FT.			
0	84	CASING	171 84.0-87.0	
84.0	87.0	3.0	172 125.0-130.0	
		SEDIMENTS - FIRST 2 GRAPHIC, LAST 1' RUSTY CARBONATE BANDS, RUSTY SPOTS THROUGHOUT	173 209.0-214.0	NIL
87.0	115.0	28.0	174 214.0-218.5	
		MAFIC TUFF - MED. GRAINED GREY/GREEN DARK COLOURED	175 228.0-233.0	NIL
115.0	211.0	96.0	176 233.0-239.3	
		DIORITIC VOLCANIC FLOW - MED. GRAINED GREY/GREEN	177 255.0-260.0	
211.0	266.0	55.0		
		AS ABOVE BUT SILICIFIED & SERICIFIED ≤ 1% DISS. PYRITE THROUGHOUT (END OF HOLE)		

Dec 16/94.

As per communication with Matti-
Kangas, the drill core is
stored: KAMISKOTIA LAKE

Alan B. Beaton

Report of Work Conducted After Recording Claim

Mining Act

Transaction Number
W9460.00217

Personal information collected on this form is obtained under the authority of the Mining Act. This information will be used for correspondence. Questions about this collection should be directed to the Provincial Manager, Mining Lands, Ministry of Northern Development and Mines, Fourth Floor, 159 Cedar Street, Sudbury, Ontario, P3E 6A5, telephone (705) 670-7264.

2.1574 7

- Instructions:**
- Please type or print and submit in duplicate.
 - Refer to the Mining Act and Regulations for requirements of the Recorder.
 - A separate copy of this form must be completed.
 - Technical reports and maps must accompany this form.
 - A sketch, showing the claims the work is assigned to, must be attached.



900

Recorded Holder(s) MATTI KANGAS		Client No. 150666
Address 128 QUEEN AVE., TIMMINS, ONT. P4N4L6		Telephone No. (705)-267-6175
Mining Division PORCUPINE	Township/Area PRICE TWP.	M or G Plan No.
Dates Work Performed	From: MAY 10/94	To: AUG. 24/94

Work Performed (Check One Work Group Only)

Work Group	Type
<input type="checkbox"/> Geotechnical Survey	
<input checked="" type="checkbox"/> Physical Work, Including Drilling	DIAMOND DRILLING
<input type="checkbox"/> Rehabilitation	
<input type="checkbox"/> Other Authorized Work	
<input type="checkbox"/> Assays	
<input type="checkbox"/> Assignment from Reserve	

RECEIVED
 DEC 13 1994
 MINING LANDS BRANCH

Total Assessment Work Claimed on the Attached Statement of Costs \$ **11,083**

Note: The Minister may reject for assessment work credit all or part of the assessment work submitted if the recorded holder cannot verify expenditures claimed in the statement of costs within 30 days of a request for verification.

Persons and Survey Company Who Performed the Work (Give Name and Address of Author of Report)

Name	Address
LARRY SALO DRILL CONTRACTOR	GENERAL DELIVERY, CONNAUGHT, ONT. P0N1A0
MATTI KANGAS DRILL SUPERVISION	128 QUEEN AVE., TIMMINS, ONT. P4N4L6
JIM CROXALL CORE LOGGING & REPORT WRITING	152 BROCK AVE., TIMMINS, ONT. P4N7P1

(attach a schedule if necessary)

Certification of Beneficial Interest * See Note No. 1 on reverse side

I certify that at the time the work was performed, the claims covered in this work report were recorded in the current holder's name or held under a beneficial interest by the current recorded holder.

Date: _____ Recorded Holder or Agent (Signature): _____

Certification of Work Report

I certify that I have a personal knowledge of the facts set forth in this Work report, having performed the work or witnessed same during and/or after its completion and annexed report is true.

Name and Address of Person Certifying: **MATTI KANGAS, 128 QUEEN AVE., TIMMINS, ONT. P4N4L6**

Telephone No: **(705)-267-6175** Date: **SEPT. 30/94** Certified By (Signature): **Matti Kangas**

For Office Use Only

Date Recorded: **OCT. 26, 1994** Mining Recorder: _____ Received Stamp: _____

Date Approved: **JAN. 24, 1995** Date Approved: _____

11083



Ministry of
Northern Development
and Mines

Ministère du
Développement du Nord
et des mines

Statement of Costs for Assessment Credit

État des coûts aux fins du crédit d'évaluation

Mining Act/Loi sur les mines

Transaction No./N° de transaction
W9460.00217

Personal information collected on this form is obtained under the authority of the Mining Act. This information will be used to maintain a record and ongoing status of the mining claim(s). Questions about this collection should be directed to the Provincial Manager, Minings Lands, Ministry of Northern Development and Mines, 4th Floor, 159 Cedar Street, Sudbury, Ontario P3E 6A5, telephone (705) 670-7264.

Les renseignements personnels contenus dans la présente formule sont recueillis en vertu de la Loi sur les mines et serviront à tenir à jour un registre des concessions minières. Adresser toute question sur la collecte de ces renseignements au chef provincial des terrains miniers, ministère du Développement du Nord et des Mines, 159, rue Cedar, 4^e étage, Sudbury (Ontario) P3E 6A5, téléphone (705) 670-7264.

1. Direct Costs/Coûts directs

Type	Description	Amount Montant	Totals Total global
Wages Salaires	Labour Main-d'oeuvre	#600	
	Field Supervision Supervision sur le terrain	#500	#1100
Contractor's and Consultant's Fees Droits de l'entrepreneur et de l'expert- conseil	Type DRILL CONTRACTOR	8,796	
	ASSAY LAB	437	
			#9,233
Supplies Used Fournitures utilisées	Type		
Equipment Rental Location de matériel	Type		

**Total Direct Costs
Total des coûts directs**

2. Indirect Costs/Coûts indirects

** Note: When claiming Rehabilitation work indirect costs are not allowable as assessment work.
Pour le remboursement des travaux de réhabilitation, les coûts indirects ne sont pas admissibles en tant que travaux d'évaluation.

Type	Description	Amount Montant	Totals Total global
Transportation Transport	Type		
Food and Lodging Nourriture et hébergement			
Mobilization and Demobilization Mobilisation et démobilisation	DRILL MOBE/DEMORB	#750	

**Sub Total of Indirect Costs
Total partiel des coûts indirects**

**Amount Allowable (not greater than 20% of Direct Costs)
Montant admissible (n'excédant pas 20 % des coûts directs)**

**Total Value of Assessment Credit
(Total of Direct and Allowable
Indirect costs)** **Valeur totale du crédit
d'évaluation
(Total des coûts directs
et indirects admissibles)**

Note: The recorded holder will be required to verify expenditures claimed in this statement of costs within 30 days of a request for verification. If verification is not made, the Minister may reject for assessment work all or part of the assessment work submitted.

Note : Le titulaire enregistré sera tenu de vérifier les dépenses demandées dans le présent état des coûts dans les 30 jours suivant une demande à cet effet. Si la vérification n'est pas effectuée, le ministre peut rejeter tout ou une partie des travaux d'évaluation présentés.

Filing Discounts

1. Work filed within two years of completion is claimed at 100% of the above Total Value of Assessment Credit.
2. Work filed three, four or five years after completion is claimed at 50% of the above Total Value of Assessment Credit. See calculations below:

Total Value of Assessment Credit Total Assessment Claimed
× 0.50 =

Remises pour dépôt

1. Les travaux déposés dans les deux ans suivant leur achèvement sont remboursés à 100 % de la valeur totale susmentionnée du crédit d'évaluation.
2. Les travaux déposés trois, quatre ou cinq ans après leur achèvement sont remboursés à 50 % de la valeur totale du crédit d'évaluation susmentionné. Voir les calculs ci-dessous.

Valeur totale du crédit d'évaluation Evaluation totale demandée
× 0,50 =

Certification Verifying Statement of Costs

I hereby certify that the amounts shown are as accurate as possible and these costs were incurred while conducting assessment work on the lands shown on the accompanying Report of Work form.

That as RECORDED HOLDER I am authorized
Recorded holder, Agent, Position in Company

To make this certification

Attestation de l'état des coûts

J'atteste par la présente que les montants indiqués sont le plus exact possible et que ces dépenses ont été engagées pour effectuer les travaux d'évaluation sur les terrains indiqués dans la formule de rapport de travail ci-joint.

Et qu'à titre de _____ je suis autorisé(e)
(titulaire enregistré, représentant, poste occupé dans la compagnie)

à faire cette attestation.

Signature

Date

[Handwritten Signature]

[Handwritten Date]



Ontario

Ministry of
Northern Development
and Mines

Ministère du
Développement du Nord
et des Mines

Geoscience Approvals Section
933 Ramsey Lake Road
6th Floor
Sudbury, Ontario
P3E 6B5

Telephone: (705) 670-5853
Fax: (705) 670-5863

December 19, 1994

Our File: 2.15747
Transaction #: W9460.00217

Mining Recorder
Ministry of Northern
Development & Mines
60 Wilson Avenue
1st Floor
Timmins, Ontario
P4N 2S7

Dear Sir/Madam:

**Subject: APPROVAL OF ASSESSMENT WORK CREDITS ON MINING CLAIMS
880301 & 880306 IN PRICE TOWNSHIP**

Assessment work credits have been approved as outlined on the report of work form for the submission. The credits have been approved under Section 16 (Drilling) and Section 17 (Assays) of the Mining Act Regulations.

The approval date is December 16, 1994.

If you have any questions regarding this correspondence, please contact Steven Beneteau at (705) 670-5855.

ORIGINAL SIGNED BY:

Yours sincerely,

Ron C. Gashinski
Senior Manager, Mining Lands Section
Mining and Land Management Branch
Mines and Minerals Division

SBB/dl

cc: Resident Geologist
Timmins, Ontario

Assessment Files Library ✓
Sudbury, Ontario

301

BRICE TWP

1

Ogden Twp. (M 305)

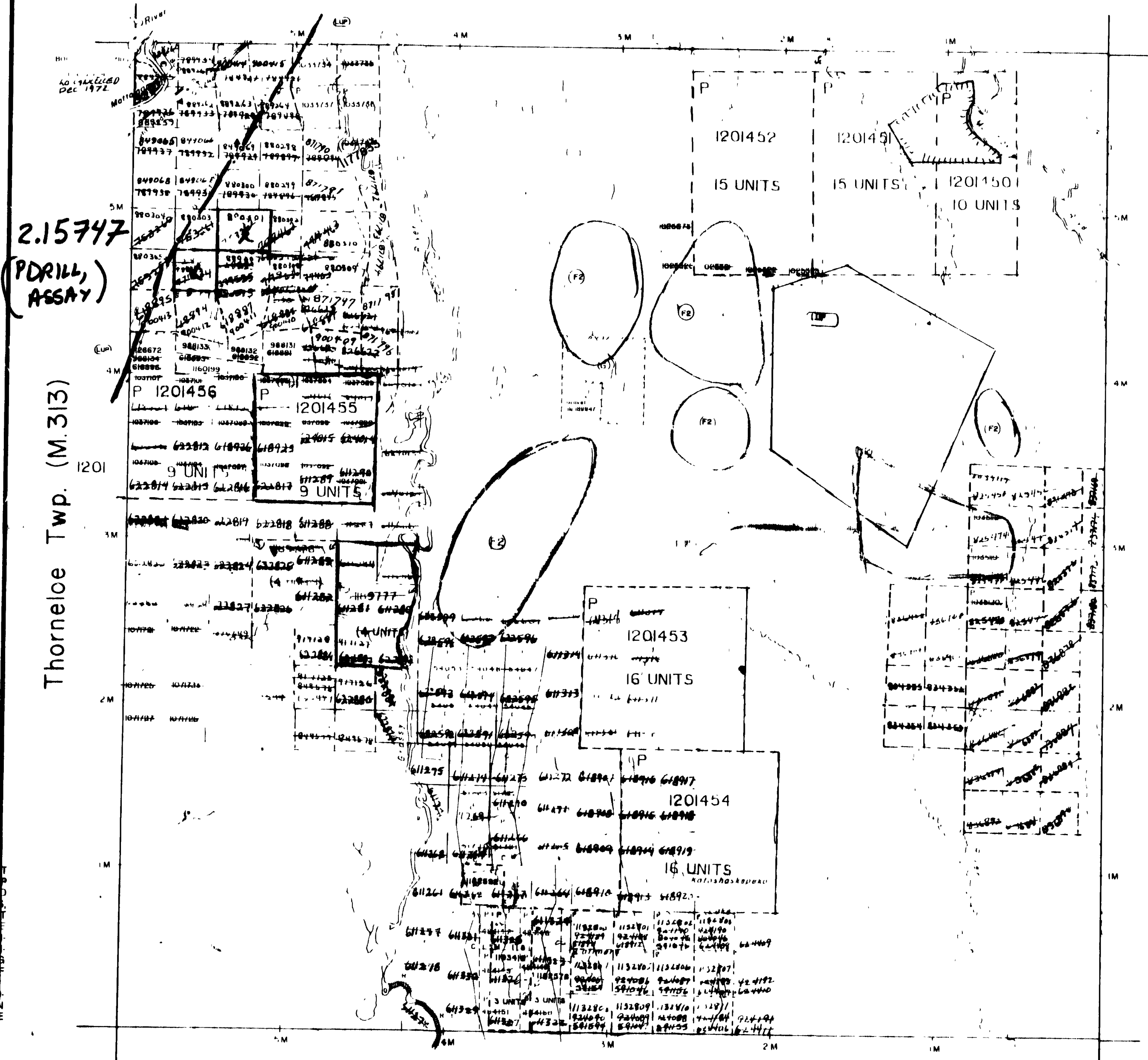

2.15747
(PDRILL,
ASSAY)

Thornelee Twp. (M.313)

Adams Twp. (M.261)

Fripp Twp. (M.281)

THE TOWNSHIP OF

PRICE

DISTRICT OF COCHRANE

PORCUPINE MINING DIVISION

SCALE: 1-INCH 40 CHAINS

DISPOSITION OF CROWN LANDS

- PATENT, SURFACE AND MINING RIGHTS
- " SURFACE RIGHTS ONLY
- " MINING RIGHTS ONLY
- LEASE, SURFACE AND MINING RIGHTS
- " SURFACE RIGHTS ONLY
- " MINING RIGHTS ONLY
- LICENCE OF OCCUPATION
- ROADS
- IMPROVED ROADS
- KING'S HIGHWAYS
- RAILWAYS
- POWER LINES
- MARSH OR MUSKEG
- MINES
- CANCELLED

NOTES

400' surface rights reservation along the shores of all lakes and rivers

Areas withdrawn from staking under Section 43 of the Mining Act (R.S.O. 1970)

Order No	File	Date	Disposition
(LUP)			APPLICATION PENDING UNDER PUBLIC LANDS ACT NOTICE RECEIVED 93-MAH-30 (SNOWMOBILE, RAIL)
			PLANNED RE FORESTATION MAY 12, 1983
(LUP)			APPLICATION PENDING UNDER PUBLIC LANDS ACT NOTICE RECEIVED 93-JUN-23 (WASTE DISPOSAL SITE)
(2)			THIS TWP. SUBJECT TO FOREST ACTIVITY IN FURTHER INFORMATION AVAILABLE IN FILE

SAND AND GRAVEL

- (6) QUARRY PERMIT

Rec. Oct 31/79

This township lies within the Municipality of the CITY of TIMMINS

PLAN NO M-307

ONTARIO
MINISTRY OF NATURAL RESOURCES
SURVEYS AND MAPPING BRANCH

THE INFORMATION THAT APPEARS ON THIS MAP HAS BEEN COMPILED FROM VARIOUS SOURCES, AND ACCURACY IS NOT GUARANTEED. THOSE WISHING TO STAKE MINING CLAIMS SHOULD CONSULT WITH THE MINING RECORDER, MINISTRY OF NORTHERN DEVELOPMENT AND MINES, FOR ADDITIONAL INFORMATION ON THE STATUS OF THE LANDS SHOWN HEREON



301

BRICE TWP

301